

70501087DD

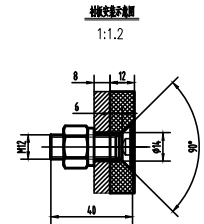
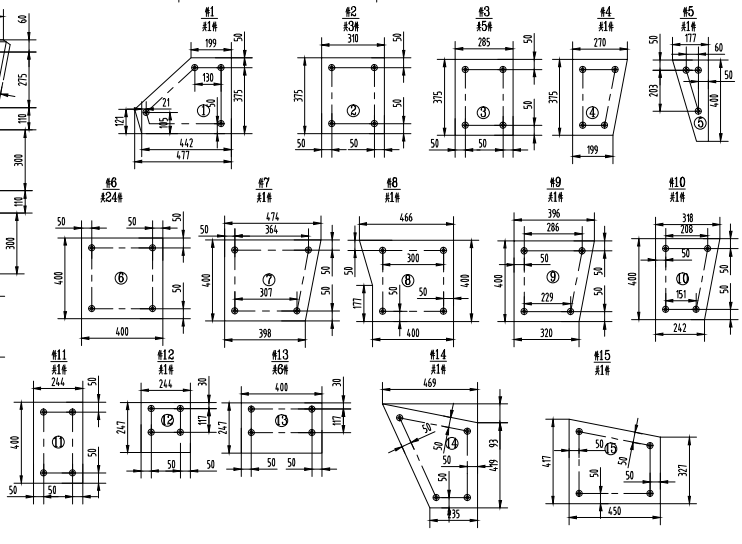
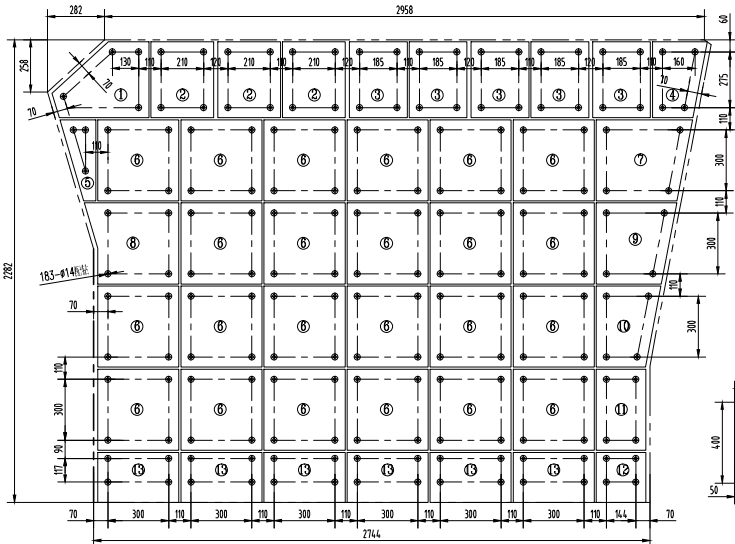
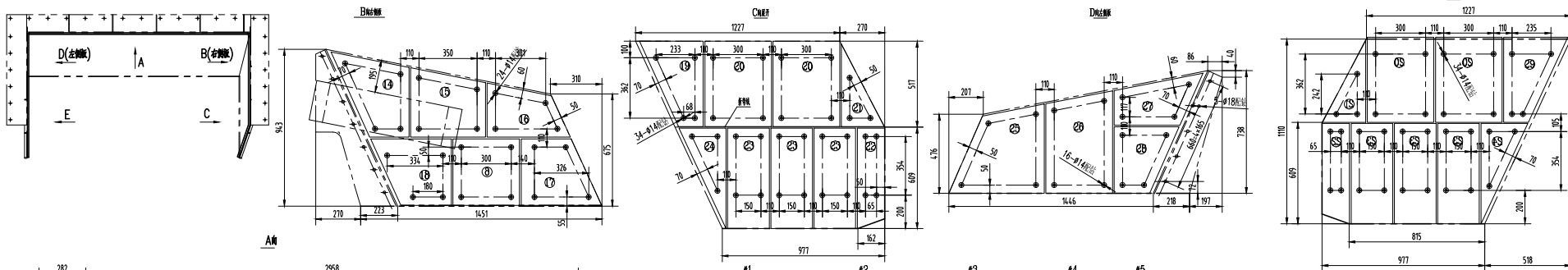

注：图中未标注尺寸均按标准图集

序号	规格	材料	数量	重量	备注
28	圆钢 12mm	ZGMn13	1	12.90	12.90
28	圆钢 12mm	ZGMn13	1	11.30	11.30
27	圆钢 12mm	ZGMn13	1	11.00	11.00
26	圆钢 12mm	ZGMn13	1	21.70	21.70
25	圆钢 12mm	ZGMn13	1	22.00	22.00
24	圆钢 12mm	ZGMn13	2	8.00	16.00 规格1
23	圆钢 12mm	ZGMn13	6	14.20	85.20 规格3
22	圆钢 12mm	ZGMn13	2	9.40	18.80 规格1
21	圆钢 12mm	ZGMn13	2	6.00	12.00 规格1
20	圆钢 12mm	ZGMn13	4	19.30	77.20 规格2
19	圆钢 12mm	ZGMn13	1	12.90	12.90
18	圆钢 12mm	ZGMn13	1	14.90	14.90
17	圆钢 12mm	ZGMn13	1	14.80	14.80
16	圆钢 12mm	ZGMn13	1	11.80	11.80
15	圆钢 12mm	ZGMn13	1	15.80	15.80
14	圆钢 12mm	ZGMn13	1	14.90	14.90
13	圆钢 12mm	ZGMn13	6	9.30	55.80
12	圆钢 12mm	ZGMn13	1	5.70	5.70
11	圆钢 12mm	ZGMn13	1	9.30	9.30
10	圆钢 12mm	ZGMn13	1	10.60	10.60
9	圆钢 12mm	ZGMn13	1	13.40	13.40
8	圆钢 12mm	ZGMn13	1	15.80	15.80
7	圆钢 12mm	ZGMn13	1	16.40	16.40
6	圆钢 12mm	ZGMn13	24	15.00	360.00
5	圆钢 12mm	ZGMn13	1	4.40	4.40
4	圆钢 12mm	ZGMn13	1	8.30	8.30
3	圆钢 12mm	ZGMn13	5	10.00	50.00
2	圆钢 12mm	ZGMn13	3	10.50	31.50
1	圆钢 12mm	ZGMn13	1	13.30	13.30

序号	图中代号	规格	名称	规格	材料	数量	重量	备注
1	ZGMn13	12mm	圆钢	ZGMn13	1	12.90	12.90	
2	967.7							

上海振华重工集团 DQ48010504

00101010705

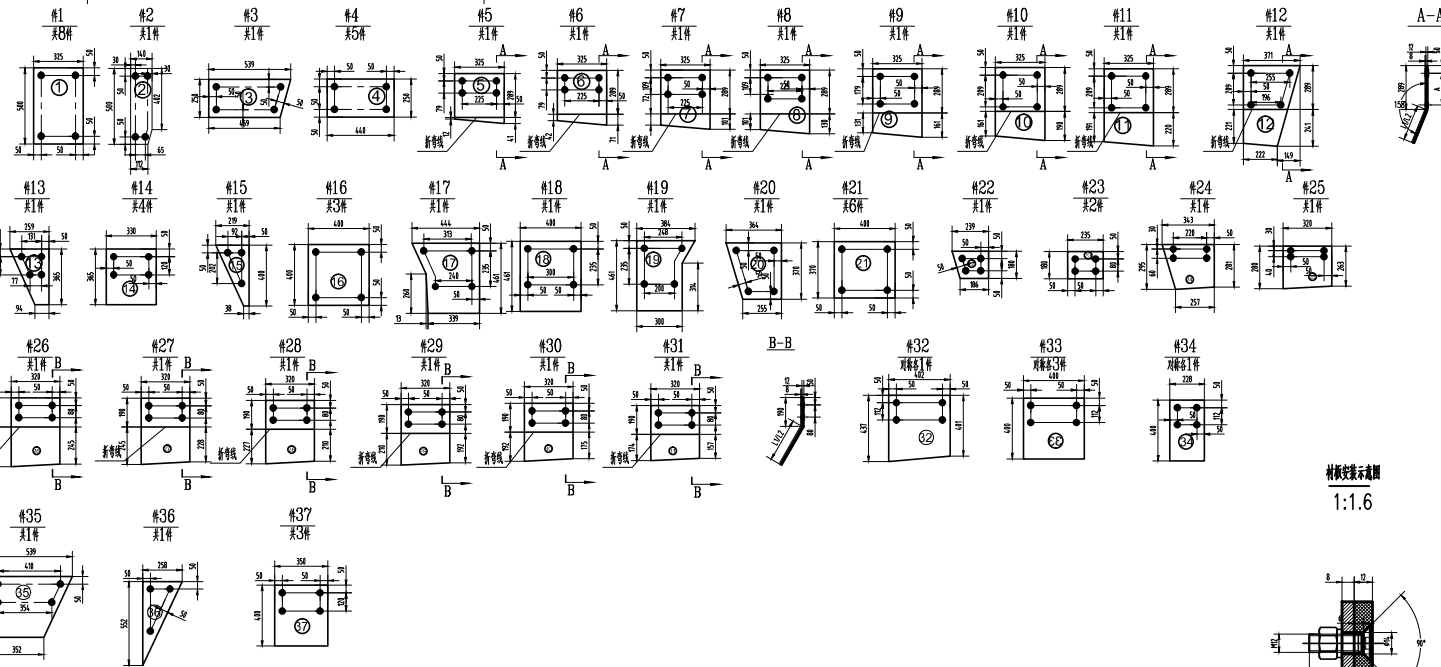
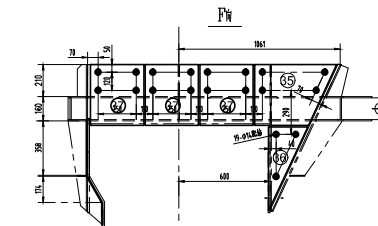
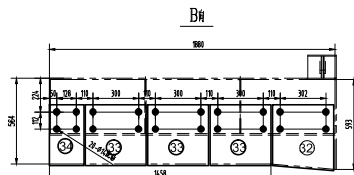
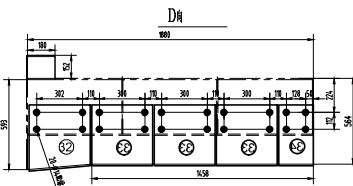
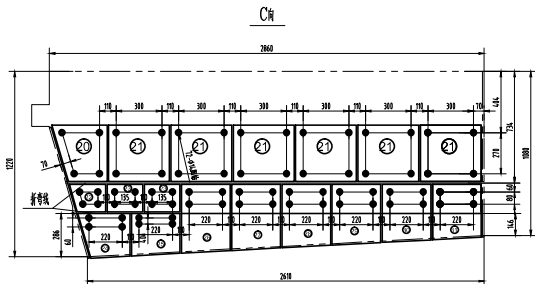
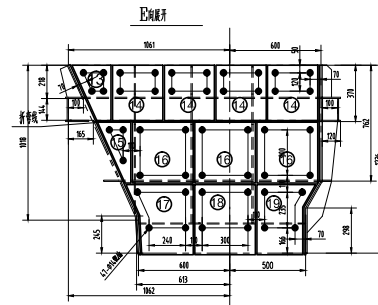
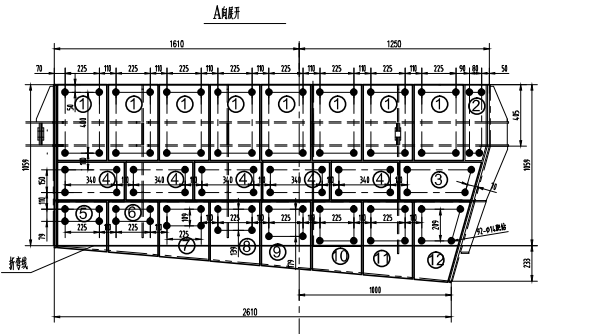
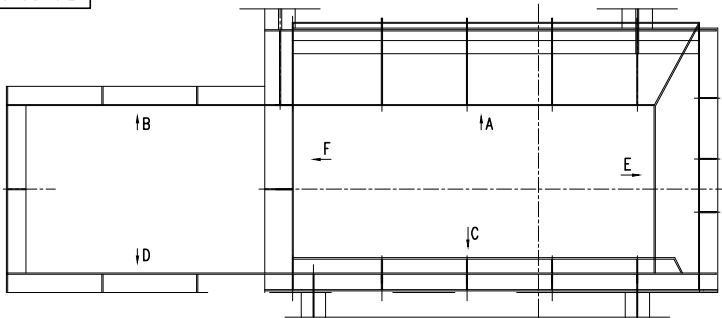

材料表示意图  
1:1.6

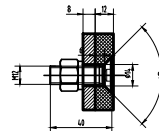

序号 NO.	图号 DRAWING NO.	图号批准 APPROVED BY	版本 VERSION	名称 DESCRIPTION	规格 SPECIFICATION	材料 MATERIAL	数量 QUANTITY	重量 WEIGHT	备注 REMARKS
37				钢筋	12mm	ZGMn13	3	13.20	39.60
36				钢筋	12mm	ZGMn13	1	6.70	6.70
35				钢筋	12mm	ZGMn13	1	16.70	16.70
34				钢筋	12mm	ZGMn13	2	8.60	17.20
33				钢筋	12mm	ZGMn13	6	15.00	90.00
32				钢筋	12mm	ZGMn13	2	15.80	31.60
31				钢筋	12mm	ZGMn13	1	10.70	10.70
30				钢筋	12mm	ZGMn13	1	11.20	11.20
29				钢筋	12mm	ZGMn13	1	11.60	11.60
28				钢筋	12mm	ZGMn13	1	12.30	12.30
27				钢筋	12mm	ZGMn13	1	12.80	12.80
26				钢筋	12mm	ZGMn13	1	13.40	13.40
25				钢筋	12mm	ZGMn13	1	8.20	8.20
24				钢筋	12mm	ZGMn13	1	8.20	8.20
23				钢筋	12mm	ZGMn13	2	4.00	8.00
22				钢筋	12mm	ZGMn13	1	3.60	3.60
21				钢筋	12mm	ZGMn13	6	13.90	83.40
20				钢筋	12mm	ZGMn13	1	10.80	10.80
19				钢筋	12mm	ZGMn13	1	13.60	13.60
18				钢筋	12mm	ZGMn13	1	17.40	17.40
17				钢筋	12mm	ZGMn13	1	16.00	16.00
16				钢筋	12mm	ZGMn13	3	15.00	45.00
15				钢筋	12mm	ZGMn13	1	4.80	4.80
14				钢筋	12mm	ZGMn13	4	11.30	45.20
13				钢筋	12mm	ZGMn13	1	6.00	6.00
12				钢筋	12mm	ZGMn13	1	14.60	14.60
11				钢筋	12mm	ZGMn13	1	15.10	15.10
10				钢筋	12mm	ZGMn13	1	14.20	14.20
9				钢筋	12mm	ZGMn13	1	13.30	13.30
8				钢筋	12mm	ZGMn13	1	12.40	12.40
7				钢筋	12mm	ZGMn13	1	11.50	11.50
6				钢筋	12mm	ZGMn13	1	10.60	10.60
5				钢筋	12mm	ZGMn13	1	9.60	9.60
4				钢筋	12mm	ZGMn13	5	10.40	52.00
3				钢筋	12mm	ZGMn13	1	11.80	11.80
2				钢筋	12mm	ZGMn13	1	6.50	6.50
1				钢筋	12mm	ZGMn13	8	15.30	122.4

Autodesk

Autodesk

设计  
校核  
审核  
工艺  
标准  
批准

DQ4820070601

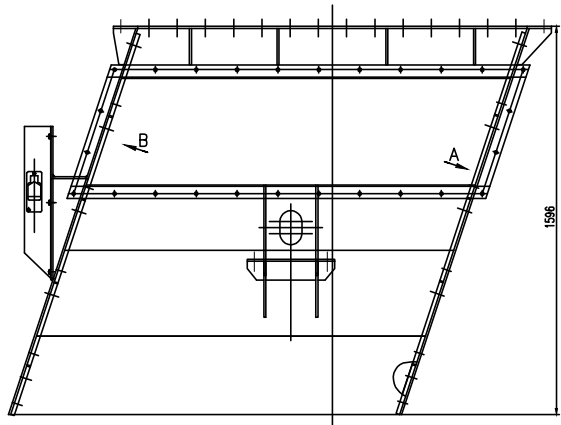

A 前

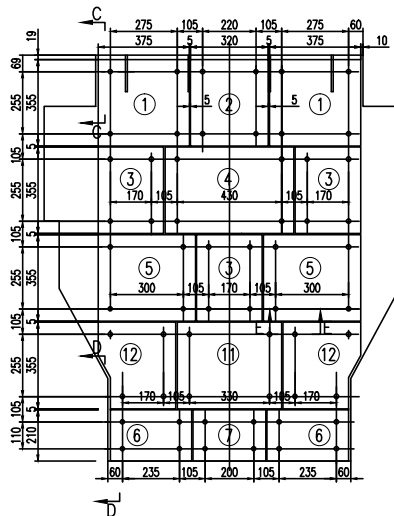

B 前

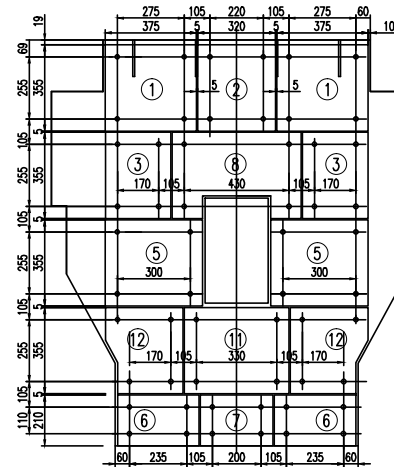

C-C

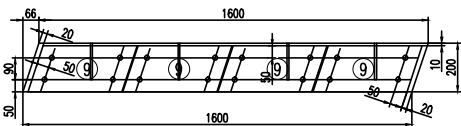

D-D

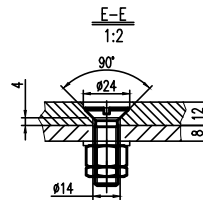
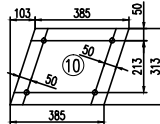
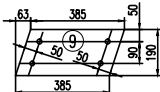
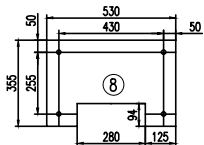
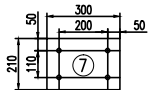
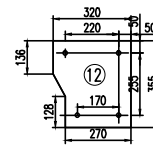
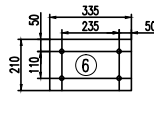
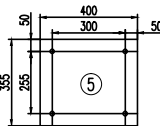
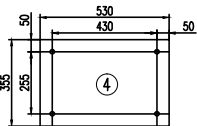
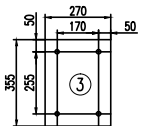
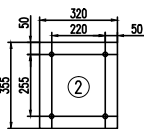
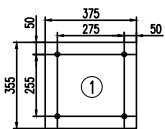
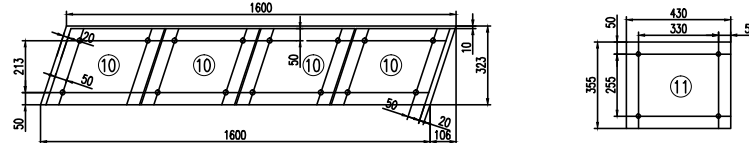

增加 件11 2件  
增加 件12 4件

序号	规格	材料	数量	重量	备注
9	镀锌钢板 1.5mm	镀锌钢板	1	11.30	外购零件
8	镀锌钢板 1.5mm	镀锌钢板	1	7.00	外购零件
7	镀锌钢板 1.5mm	镀锌钢板	1	15.20	15.20
6	镀锌钢板 1.5mm	镀锌钢板	2	7.87	15.74
5	镀锌钢板 1.5mm	镀锌钢板	4	6.60	26.40
4	镀锌钢板 1.5mm	镀锌钢板	4	13.30	53.20
3	镀锌钢板 1.5mm	镀锌钢板	1	17.70	53.10
2	镀锌钢板 1.5mm	镀锌钢板	5	9.00	45.00
1	镀锌钢板 1.5mm	镀锌钢板	2	18.70	37.40

序号	图号或标准	版本	名称	规格	材料	数量	重量	备注
1	外购件		衬板	110				

所有衬板外形(轴径)公差为-3mm ~ -4mm